



Irrigation Products

Offering a complete range of stainless steel and galvanised wire ropes and fittings for irrigation systems.

Irrigation Products



Designed for the toughest irrigation applications, our products deliver quality, reliability and value.

Arcus Wire Group (AWG) is a specialist supplier and manufacturer of stainless and steel wire ropes, fittings and accessories. Operating within Australia for over 50 years AWG supplies materials to industries including Marine, Industrial and Agricultural.

Both warehouses in Sydney and the Gold Coast stock a wide range of products including wire rope from 1mm up to 42mm. Our in-house machinery includes a new 250t test bed and hydraulic swaging tools capable of pressing wire rope up to 42mm.

If you require any irrigation solutions from bore pump cable assemblies, travelling irrigator cable or a fully engineered and tested control cable, AWG has you covered.

For more information please give us a call or visit www.arcuswire.com to view our full range our wire ropes and fittings.

Thimble

SF234U

PRODUCT CODE	SIZE (MM)	B (MM)	L (MM)	T (MM)	
HM-6234-0003	3	12.5	28.5	1	3,500
HM-6234-0004	4	13	33.0	1.2	2,000
HM-6234-0005	5	15.5	36.5	1.2	1,500
HM-6234-0006	6	17	40	1.5	1,000
HM-6234-0008	8	22.5	51	1.5	500
HM-6234-0010	10	26	58.5	2	300

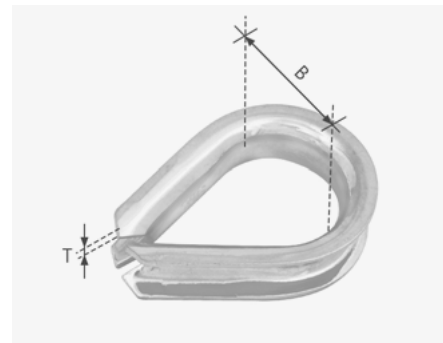

Wire Rope Grip

S260

PRODUCT CODE	SIZE (MM)	B (MM)	L (MM)	M (MM)	
HM-6260-0003	3	8	21	M3	2,500
HM-6260-0004	4	10	23	M4	1,200
HM-6260-0005	5	12	29	M5	800
HM-6260-0006	6	14	32	M6	500
HM-6260-0008	8	17.5	40	M8	300
HM-6260-0010	10	21	50	M10	200



Galvanised Bore Pump Cable

G2070 7x19

PRODUCT CODE	SIZE (MM)	REEL SIZE	MBL (KN)	MBL (KGF)	WEIGHT P/M
G079032-1000	3.2mm	1000m	7.1	723	0.039
G079032C	3.2mm	Cut	7.1	723	0.039
G079040-1000	4.0mm	1000m	10.3	1,051	0.061
G079040C	4.0mm	Cut	10.3	1,051	0.061
G079050-1000	5.0mm	1000m	16.0	1,632	0.095
G079050C	5.0mm	Cut	16.0	1,632	0.095
G079060-1000	6.0mm	1000m	23.1	2,356	0.137
G079060C	6.0mm	Cut	23.1	2,356	0.137

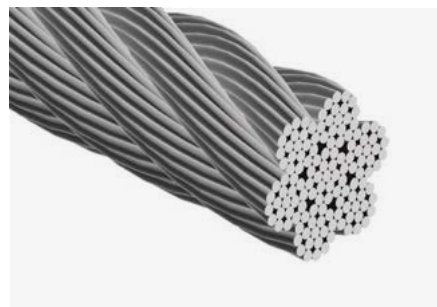

Stainless Bore Pump Cable

hamma® X G316 7x19

PRODUCT CODE	SIZE (MM)	REEL SIZE	MBL (KN)	MBL (KGF)	WEIGHT P/M
HMX79032-305	3.2mm	305m	6.0	611	0.043
HMX79032C	3.2mm	Cut	6.0	611	0.043
HMX79040-305	4.0mm	305m	9.4	956	0.067
HMX79040C	4.0mm	Cut	9.4	956	0.067
HMX79050-305	5.0mm	305m	14.6	1,490	0.104
HMX79050C	5.0mm	Cut	14.6	1,490	0.104
HMX79060-305	6.0mm	305m	20.6	2,105	0.150
HMX79060C	6.0mm	Cut	20.6	2,105	0.150

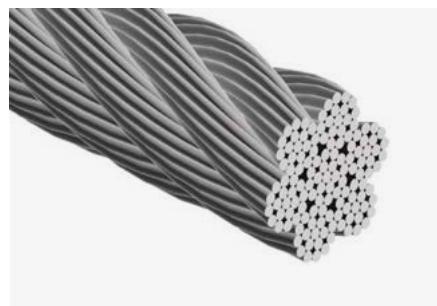

Galvanised Travelling Irrigator Cable

G2070 7x7

PRODUCT CODE	SIZE (MM)	REEL SIZE	MBL (KN)	MBL (KGF)	WEIGHT P/M
G077050-1000	5.0mm	1000m	17.2	1,754	0.096
G077050C	5.0mm	Cut	17.2	1,754	0.096
G077060-1000	6.0mm	1000m	24.7	2,519	0.138
G077060C	6.0mm	Cut	24.7	2,519	0.138
G077070-1000	7.0mm	1000m	33.6	3,427	0.188
G077070C	7.0mm	Cut	33.6	3,427	0.188
G077080-1000	8.0mm	1000m	43.9	4,478	0.246
G077080C	8.0mm	Cut	43.9	4,478	0.246
G077090-1000	9.0mm	1000m	59.3	6,046	0.320
G077090C	9.0mm	Cut	59.3	6,046	0.320
G077100-1000	10.0mm	1000m	68.9	7,026	0.384
G077100C	10.0mm	Cut	68.9	7,026	0.384



Slip Hook (Eye End with Safety Latch)

S325X

PRODUCT CODE	SIZE (INCH)	ØB (MM)	L (MM)	O (MM)		B.L. (KGS)
HM-6325-5516	5/16"	16	108	24	100	2,900



Twisted Shackle

S380

PRODUCT CODE	SIZE (MM)	ØA (MM)	B (MM)	L (MM)		B.L. (KGS)
HM-6380-0006	6	6	12	36	600	1,600
HM-6380-0008	8	8	16	44	180	2,800



Twisted Shackle with Collared Pin

S380CP

PRODUCT CODE	SIZE (MM)	ØA (MM)	B (MM)	L (MM)		B.L. (KGS)
HM-6360-8010	10	10	20	51	200	4,600



D Shackle

S360

PRODUCT CODE	SIZE	ØA (MM)	B (MM)	L (MM)		B.L. (KGS)
HM-6360-0006	6	6	12	24	1,200	1,700
HM-6360-0008	8	8	16	32	500	2,800



D Shackle with Collared Pin

S360CP

PRODUCT CODE	SIZE (MM)	ØA (MM)	B (MM)	L (MM)		B.L. (KGS)
HM-6360-0410	10	10	20	40	250	4,500
HM-6360-0412	12	12	24	48	150	6,000



D Shackle Long

S362

PRODUCT CODE	SIZE (MM)	ØA (MM)	B (MM)	L (MM)		B.L. (KGS)
HM-6362-0008	8	8	16	64	300	2,500



D Shackle Long with Collared Pin

S362CP

PRODUCT CODE	SIZE (MM)	ØA (MM)	B (MM)	L (MM)		B.L. (KGS)
HM-6362-3010	10	10	20	80	150	3,500
HM-6362-3012	12	12	24	96	80	5,400



Eye-Eye Turnbuckle

S311EE

PRODUCT CODE	SIZE (MM)	L (MM)	L1 (MM)	M (MM)		B.L. (KGS)
HM-6311-7006	6	154	90	M6	300	1,500
HM-6311-7008	8	210	120	M8	150	2,300
HM-6311-7010	10	257	150	M10	80	3,100



Nicopress N5606 Battery Tool

N5606

PRODUCT CODE	SUITS (MM)	CRIMP TIME	WEIGHT	CRIMPS PER CHARGE
N5606	N24C, N32C, N40C, N48C, N55C, N64C, N80C and N95C	6 seconds	3.8kgs	250

SPECIAL NOTE

N5606 Battery Tool suits Nicopress N5606 Dies.
Includes Tool, Wrist Strap, Two Batteries, Battery Charger and Moulded Carrying case.



Nicopress N5606 Dies

N5606

PRODUCT CODE	SUITABLE TO USE WITH
NBTD2.4MM	2.4mm, 2.5mm or 3/32"
NBTD3.2MM	3.0mm, 3.2mm, 3.5mm or 1/8"
NBTD4MM	4.0mm or 5/32"
NBTD4.8MM	4.8mm, 5.0mm or 3/16"
NBTD5.5MM	5.5mm, 6.0mm or 7/32"
NBTD6.4MM	7.0mm, 6.4mm or 1/4"
NBTD8MM	7.2mm, 8.0mm, 9/32" or 5/16"
NBTD9.6MM	10.0mm or 3/8"



SPECIAL NOTE

N5606 can swage all sleeves noted below.

Nicopress Tin Plated Oval Sleeves

Hand Swage

PRODUCT CODE	TOOL REQUIRED
N08C	N31B
N12C	N17-B4B or N33V
N16C	N5606, N33V or N64CG
N24C	N5606, N33V or N64CG
N32C	N5606, N33V or N64CG
N40C	N5606, N33V or N64CG
N48C	N5606 or N63V
N55C	N5606 or N51F
N64C	N5606 or N3F6
N80C	N5606 or N3G9
N95C	N5606 or N3H5



SPECIAL NOTE

When swaging correctly Nicopress ferrules reach 100% of the MBL of the wire rope. Above ferrules are also available in plain copper or black oxide upon request. N5606 can swage all sleeves noted above.

Nicopress Stainless Steel Oval Sleeves

PRODUCT CODE	TOOL REQUIRED
N12SS	N33V
N16SS	N51-B4-887
N24SS	N51C-887
N32SS	N51-G-887 or N63V
N40SS	N51M or N63V
N48SS	N-51-P-850 or N63V
N55SS	N-3-X-950
N64SS	N-3-F2-950



Nicopress Copper Stop Ferrules

PRODUCT CODE	TOOL REQUIRED
N12ST	N51-B4-887 or N17-B4B
N16ST	N51C or N64CG
N24ST	N51M
N32ST	N51M
N40ST	N51M
N48ST	N51M



SPECIAL NOTE

Stop Sleeves typically hold between 30-50% of the MBL of the cable.

Nicopress Aluminum Stop Ferrules

PRODUCT CODE	TOOL REQUIRED
N32STA	N51-C-887 or N64CG
N40STA	N51M
N48STA	N51M
N64STA	N3F6
N80STA	N3F6



SPECIAL NOTE

Stop Sleeves typically hold between 30-50% of the MBL of the cable.

Nicopress Hand Model Crimping tool

N17-B4B

PRODUCT CODE	SUITABLE FOR USE WITH
N17-B4B	N12C, N12ST or N24SS



Nicopress 33V-CGB4 Swaging Tool

N33V

PRODUCT CODE	SUITABLE FOR USE WITH
N33V	N16C, N24C or N32SS



Nicopress 64-CGMP Swaging Tool

N64CG

PRODUCT CODE	SUITABLE FOR USE WITH
N64CG	N16C, N24C, N32C, N40C, N16ST, N32STA, N32SS



Nicopress 63V-XPM Swaging Tool

N63V

PRODUCT CODE	SUITABLE FOR USE WITH
N63V	N32C, N40C, N48C, N32SS, N40SS, N48SS



Nicopress 51-F2-850 Swaging Tool

N51F

PRODUCT CODE	SUITABLE FOR USE WITH
N51F	N55C, N64C



Nicopress 51-MJ Swaging Tool

N51M

PRODUCT CODE	SUITABLE FOR USE WITH
N51M	N40SS, N24ST, N32ST, N40ST, N48ST, N40STA, N48STA



Nicopress 3-F6-950 Swaging Tool

N3F6

PRODUCT CODE	SUITABLE FOR USE WITH
N3F6	N64C, N64STA, N80STA



Nicopress 3-G9-950 Swaging Tool

N3G9

PRODUCT CODE	SUITABLE FOR USE WITH
N3G9	N80C



Go gauge usage

Gauging swaged sleeves is an important inspection process to determine if a sleeve has been pressed enough to ensure a full-strength connection to wire rope. Nicopress go gauges are provided with each tool. It's always recommended, while adjusting a hand tool, to gradually increase the compression of the tool to a point where the Nicopress "go-gauge" easily slides (or "goes") over the pressed sleeve resulting in an optimum swage compression.

It's a "go" gauge, not a "go-no-go" gauge

A Nicopress "go" gauge is a gauge designed to easily slide or "go" over a properly swaged section of sleeve to be sure a safe amount of compression has been reached. If the gauge tool doesn't slide easily over the swage, or doesn't go, the swage tool must be adjusted to press deeper to allow the gauge to freely pass or "go" over the swage. In theory, this would be an inspection tool to prevent under-pressing occurring during a swaging process.

Refer to *Technical Bulletin-2* for "Go-Gauge" or "Go-No-Go" Gauge details.

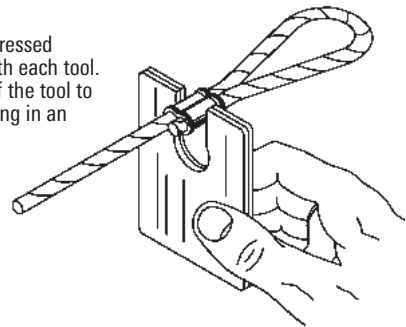



FOR MORE INFORMATION
1800 272 879
SALES@ARCUSWIRE.COM

arcuswire.com